

P24T - CHASSIS MOUNT WITH QUICK-CONNECT TERMINALS ISOLATION TRANSFORMER

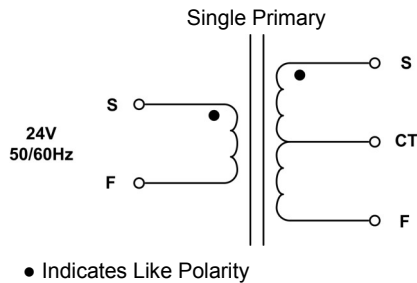
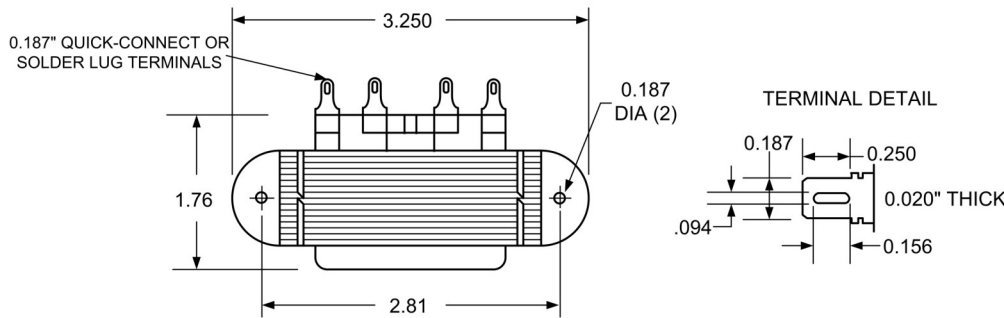
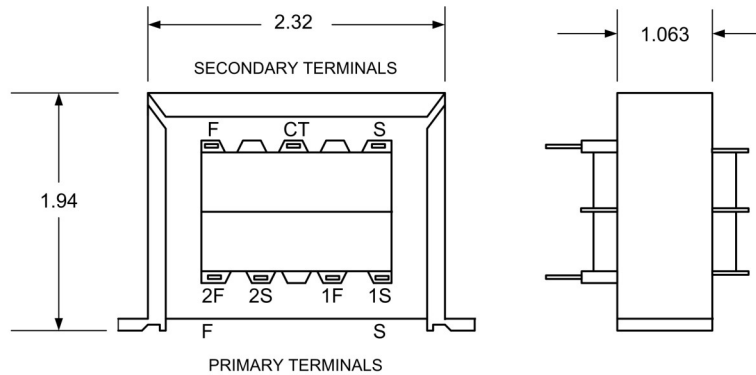

1. Electrical Specifications

- A. Maximum Power: 30 VA
- B. Input Voltage and Frequency: 24V @ 50/60Hz
- C. Voltage Regulation: __% TYP @ Full Load to No Load
- D. Temperature Rise: __°CTYP
- E. Insulation Resistance: < __ MEG ohm
- F. Hi-Pot: 2500 Vrms 1 minute @ Pri to Sec
 ___ Vrms 1 minute @ Pri to Core
 ___ Vrms 1 minute @ Sec to Core

2. Marking: Wabash Transformer, part number (see table), date code, terminal numbers

3. Safety:
 UL/cUL 5085-2 Recognized (File E182486)
 Insulation File No. E182094



Part No.	Secondary 24V
P24T-30-24	24VCT @ 1.25A

	ISOLATION TRANSFORMER	P24T-30-XX	
CONTENTS OF THIS DRAWING ARE SUBJECT TO CHANGE WITHOUT PRIOR NOTICE	Wabash Transformer 101 Industrial Park Drive, Clarence, IA 52216	Dim: Inches	Sheet 1 of 1

PROPRIETARY NOTICE: THIS DRAWING PRINT OR DOCUMENT AND SUBJECT MATTER DISCLOSED HEREIN ARE PROPRIETARY ITEMS TO WHICH WABASH TRANSFORMER RETAINS THE EXCLUSIVE RIGHT OF DISSEMINATION, MANUFACTURE AND SALE. THIS DRAWING, PRINT OR DOCUMENT IS SUBMITTED IN CONFIDENCE FOR CONSIDERATION BY THE RECIPIENT ALONE UNLESS PERMISSION FOR FURTHER DISCLOSURE IS EXPRESSLY GRANTED IN WRITING