

PSL & PDL - CHASSIS MOUNT WITH LEAD WIRES, POWER TRANSFORMER

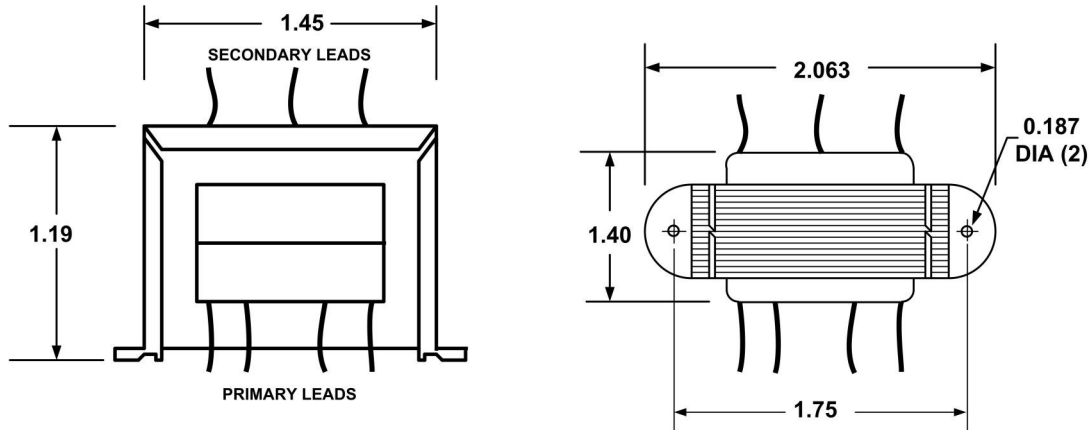

1. Electrical Specifications
 - A. Maximum Power: 2.4 VA
 - B. Input Voltage and Frequency: 115V & 115/230V @ 50/60Hz
 - C. Hi-Pot: 2500 Vrms 1 minute
2. Marking: Wabash Transformer, part number (see table), date code, terminal numbers
3. Agency Approval:
 - UL/cUL 5085-2 Recognized (File E47299)
 - Insulation File No. E95662

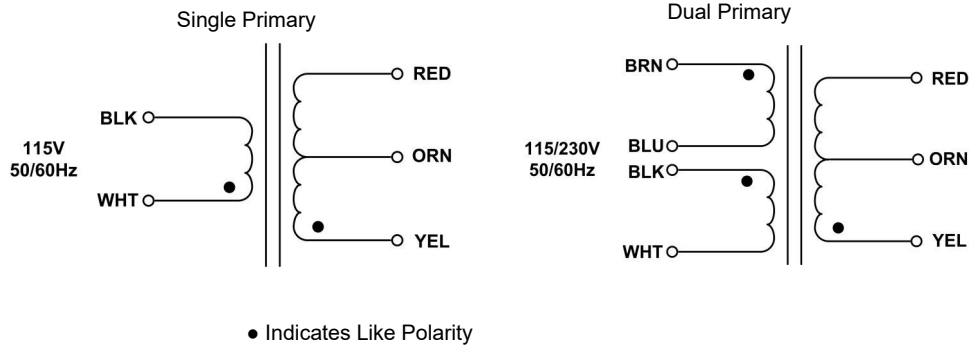

Part No.		
115V	115/230V	Secondary
PSL-24-10	PDL-24-10	10VCT @ 0.240A
PSL-24-126	PDL-24-126	12.6VCT @ 0.190A
PSL-24-16	PDL-24-16	16VCT @ 0.150A
PSL-24-20	PDL-24-20	20VCT @ 0.120A
PSL-24-24	PDL-24-24	24VCT @ 0.100A
PSL-24-28	PDL-24-28	28VCT @ 0.085A
PSL-24-36	PDL-24-36	36VCT @ 0.066A
PSL-24-48	PDL-24-48	48VCT @ 0.050A
PSL-24-56	PDL-24-56	56VCT @ 0.043A
PSL-24-120	PDL-24-120	120VCT @ 0.020A

	POWER TRANSFORMER	PSL-24-XXX PDL-24-XXX	
CONTENTS OF THIS DRAWING ARE SUBJECT TO CHANGE WITHOUT PRIOR NOTICE	Wabash Transformer 101 Industrial Park Drive, Clarence, IA 52216	Dim: Inches	Sheet 1 of 1
<small>PROPRIETARY NOTICE: THIS DRAWING PRINT OR DOCUMENT AND SUBJECT MATTER DISCLOSED HEREIN ARE PROPRIETARY ITEMS TO WHICH WABASH TRANSFORMER RETAINS THE EXCLUSIVE RIGHT OF DISSEMINATION, MANUFACTURE AND SALE. THIS DRAWING, PRINT OR DOCUMENT IS SUBMITTED IN CONFIDENCE FOR CONSIDERATION BY THE RECIPIENT ALONE UNLESS PERMISSION FOR FURTHER DISCLOSURE IS EXPRESSLY GRANTED IN WRITING</small>			